

INSTRUCTIONS

These paper spaceships are easy to make and they really do fly. The only tools you will need are

- scissors
- transparent tape
- cardboard
- paper clips
- ruler or other straightedge

Begin by cutting out one of the spaceships, following the heavy black outline as carefully as you can.

Next, protect your work table by covering it with a piece of cardboard. Lay the cutout on the cardboard and score along the fold lines (single or double dashed lines). Single dashed lines tell you to fold back, so that the lines remain visible to you. Double dashed lines tell you to fold forward, so that the lines get hidden in the fold. (See Figure A.)

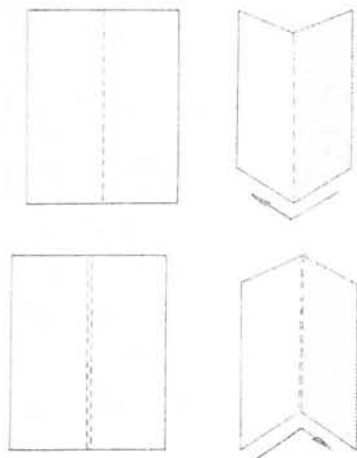

Figure A

Score single lines by laying a ruler next to them and drawing a scissors point along the whole length; apply some pressure, but not so much as to cut through the paper. Score double dashed lines *halfway* between the two.

After you've scored all the fold lines, fold them in sequence, following the order of the circled numbers. As you do this, refer to the explanatory diagrams that show you step-by-step how each spaceship is made, including when and how the

tail plane is raised above the fuselage in some models. (See Figure B.) Note that to achieve the proper symmetry, the same folds are made on both wings. It is essential that all folds be made crisply and exactly where indicated.



Figure B

Before flying the spaceship, give the nose a little extra weight by adding a paper clip. You may also want to secure folds with little pieces of transparent tape. (See Figure C.)

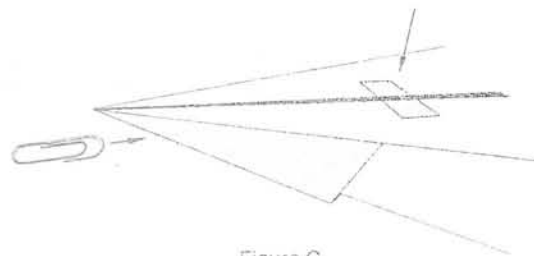
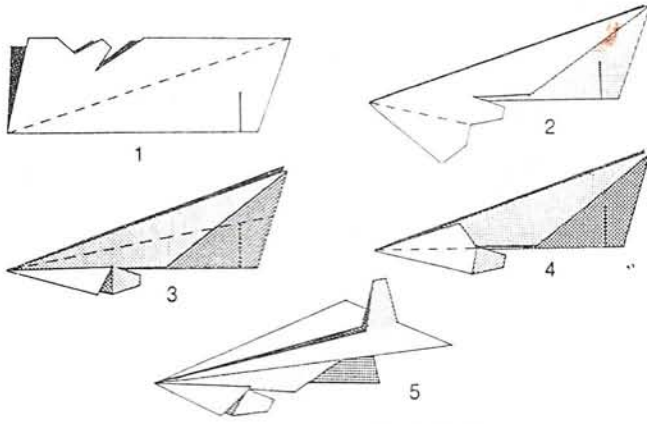

Figure C

Test fly the spaceship, increasing or decreasing the angle where the wings meet the fuselage until you find the dihedral that works best. If the spaceship corkscrews or spins when launched, the configuration of the wings is irregular because some of the folds have not been done precisely right. Correct this by unfolding and refolding more carefully.

EXPLANATORY DIAGRAMS FOLLOW PLATES

EXPLANATORY DIAGRAMS



1. ORBITAL ZOOM RIDER

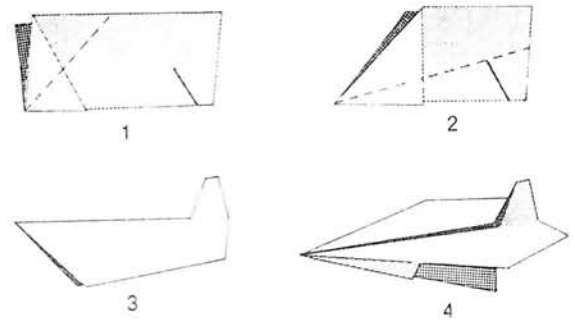

2. SIGNAL LINK

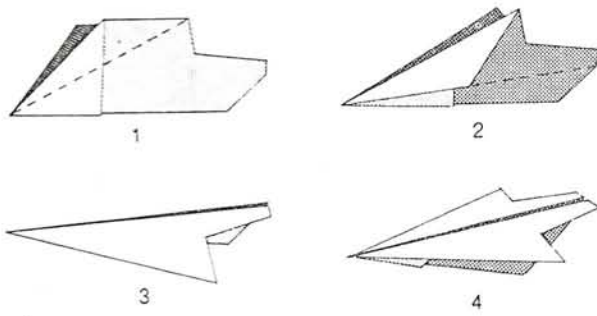

3. INTRUDER

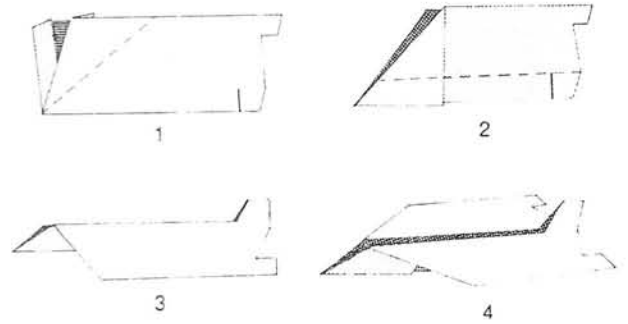

4. STAR TRANSPORTER

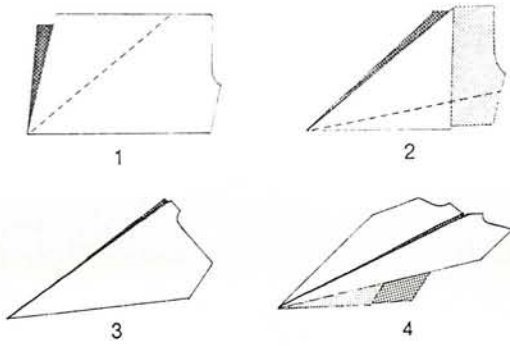

5. ROUTEFINDER

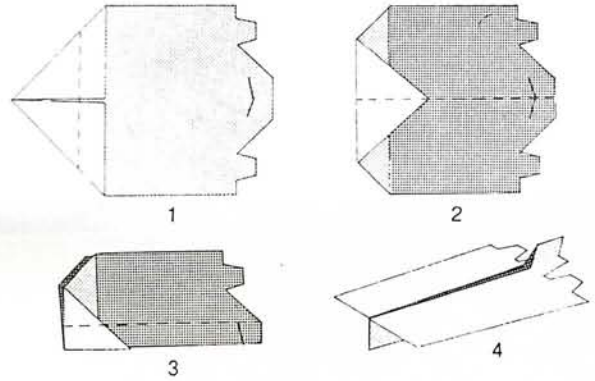

6. SPACE RAM

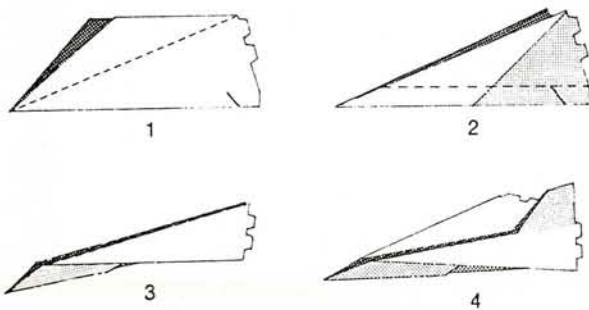

7. SUPERCONTINENTAL

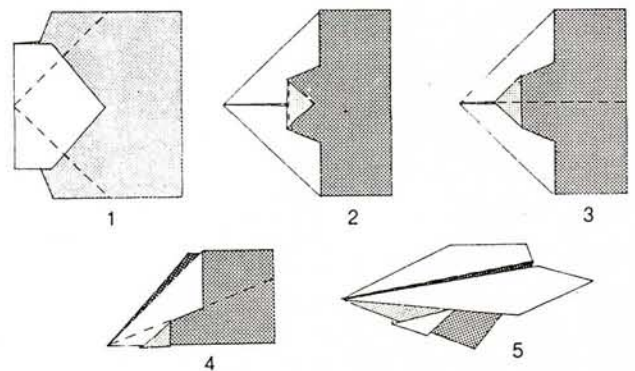

8. STAR PROBE

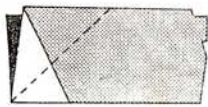

1

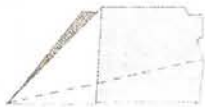

2

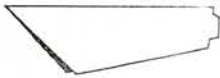

3



4

9. SPACE SEARCHER



2



4

10. SKYCAT



1



2



3



4

11. SPACE SENTINEL



2



4

12. STAR CRUISER

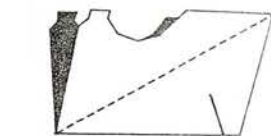

1

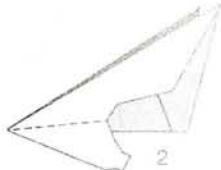

2

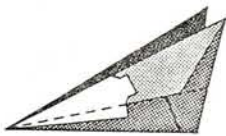

3

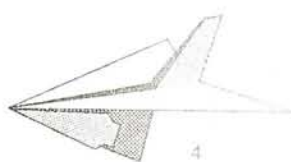

4

13. STAR SHUTTLE



2



4

14. LUNAR FREIGHTER

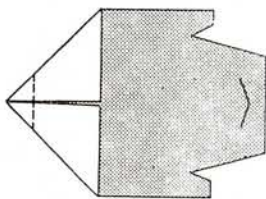

1

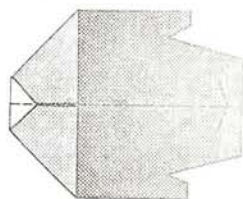

2

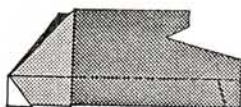

3



4

15. STAR GIANT



2



4

16. STAR LINK

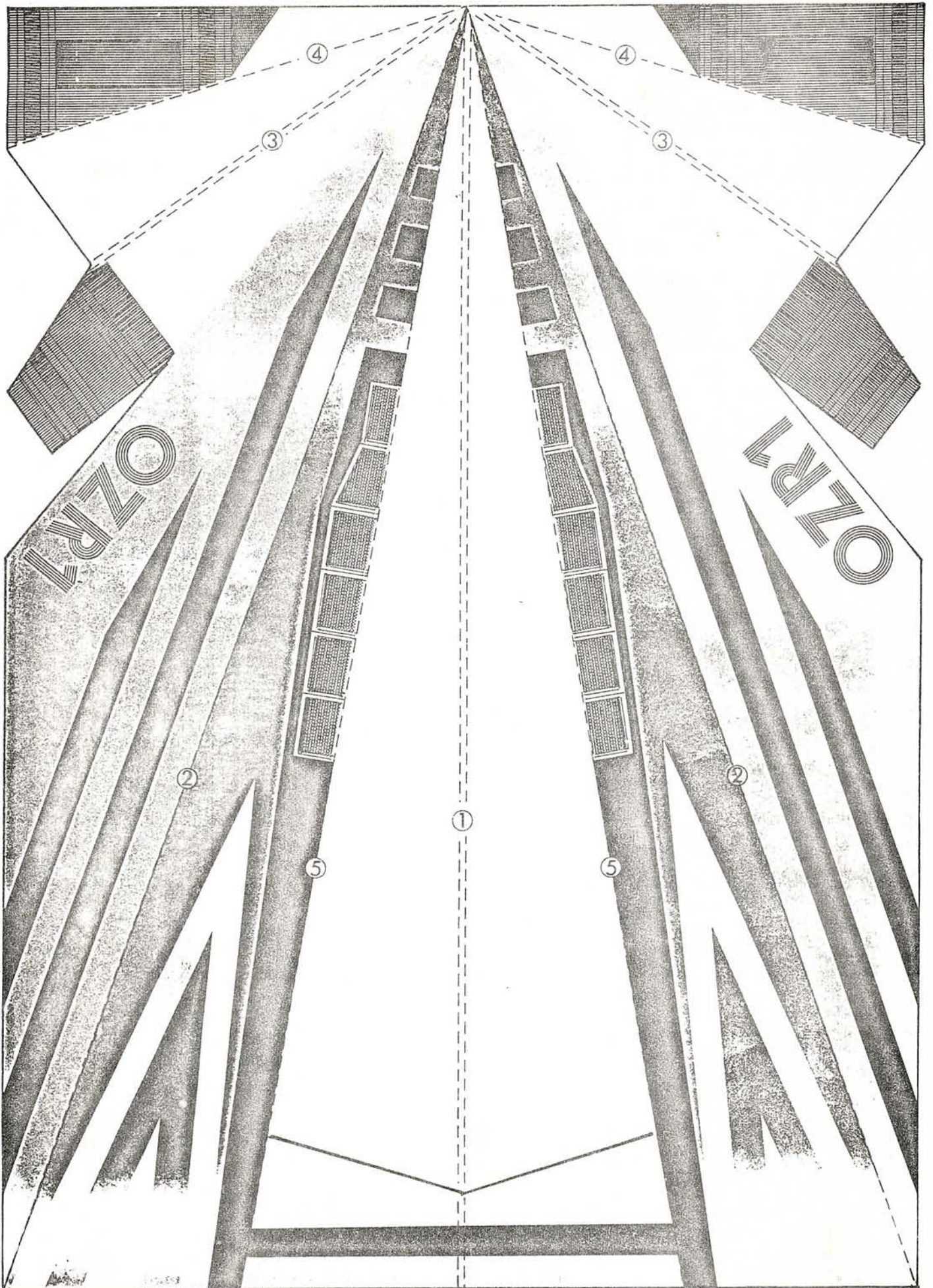

1. ORBITAL ZOOM RIDER

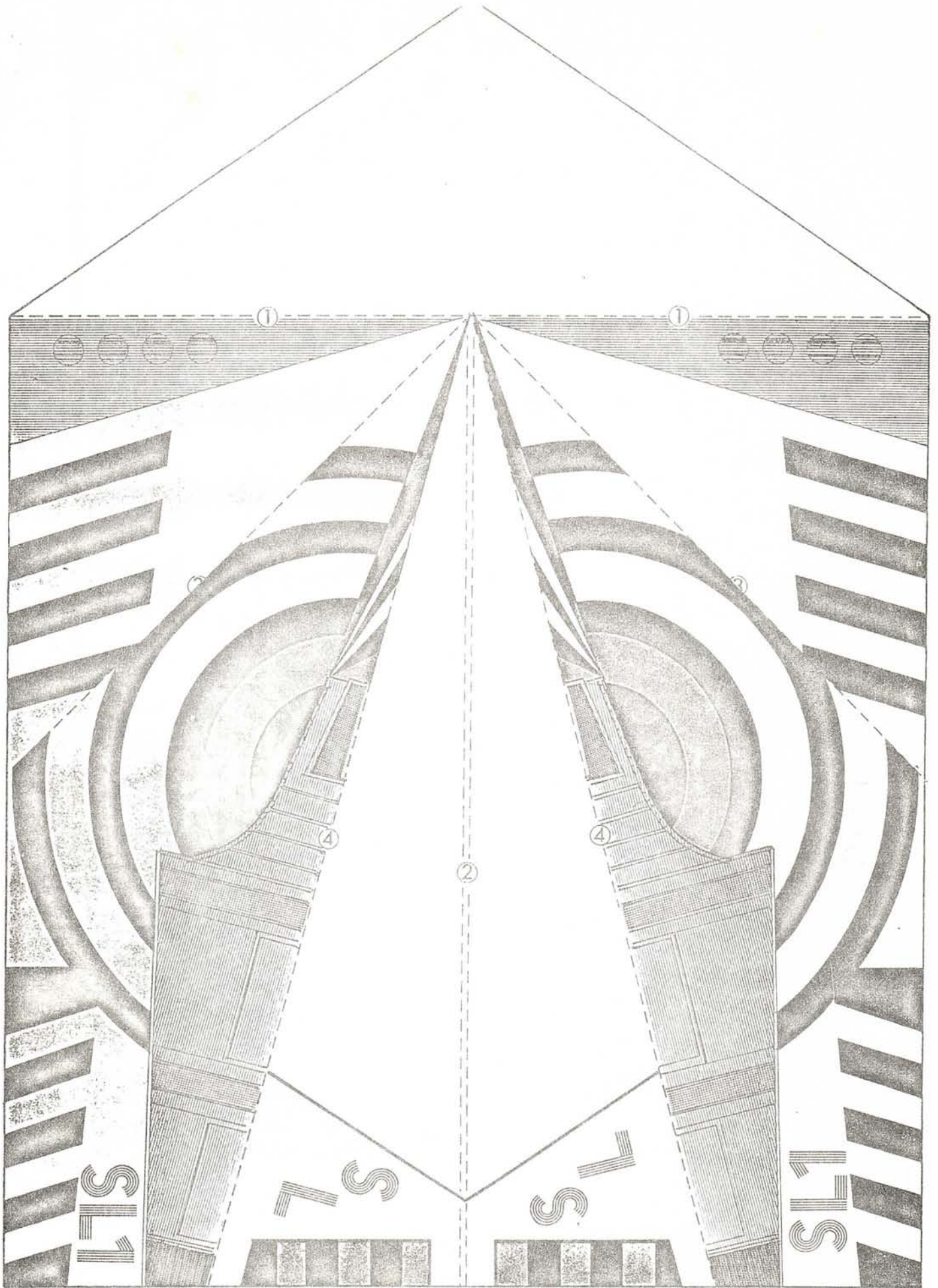

2. SIGNAL LINK

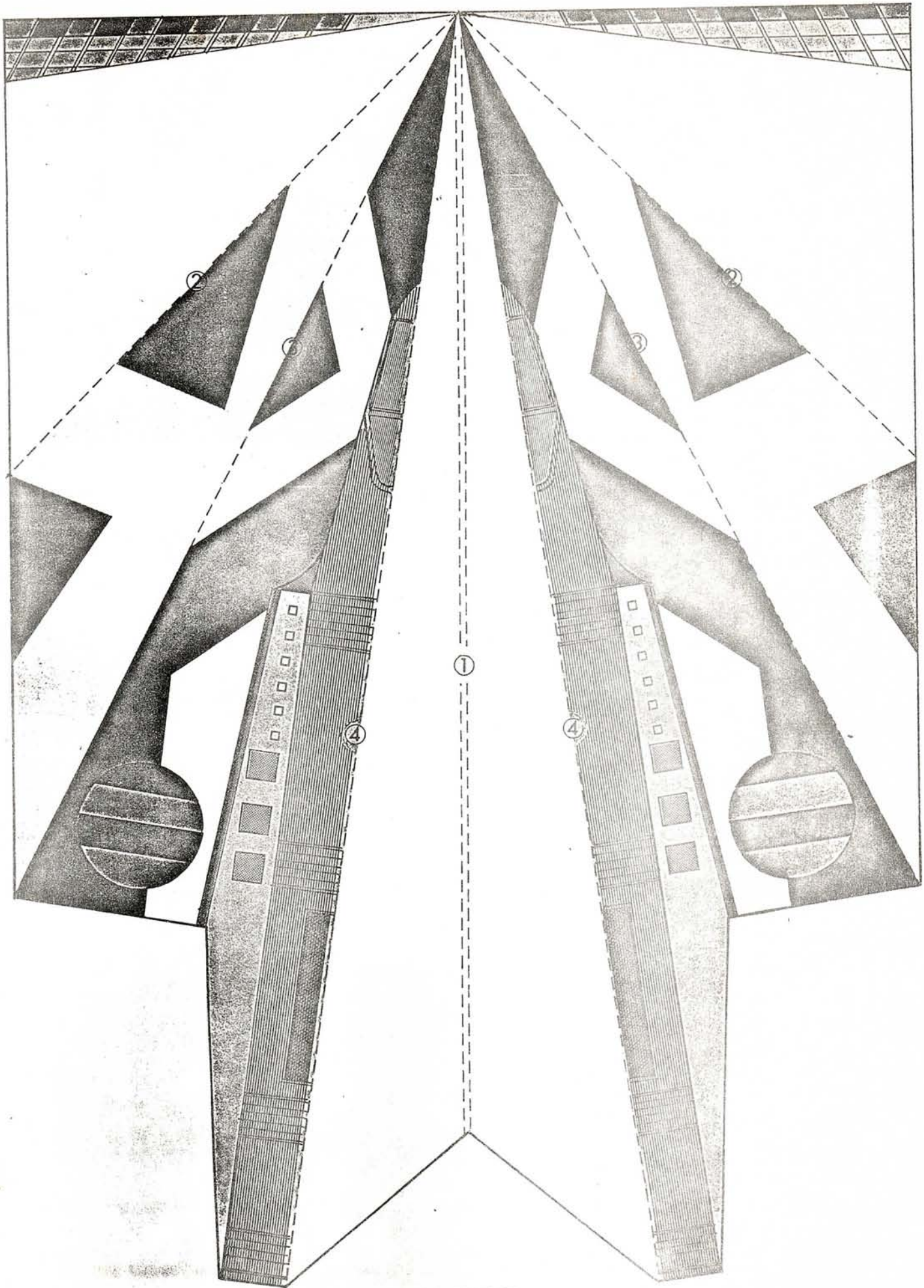

3. INTRUDER

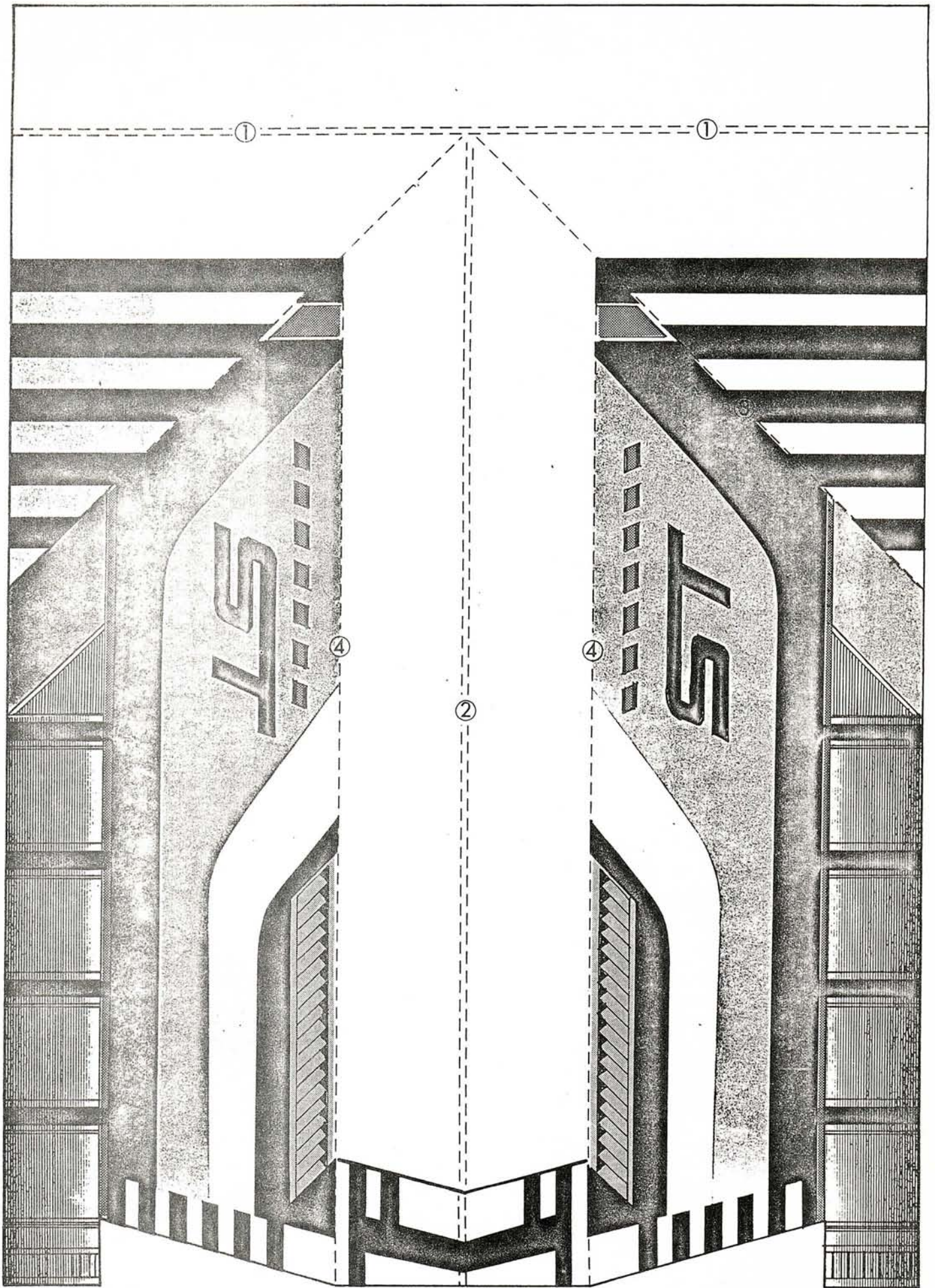

4. STAR TRANSPORTER

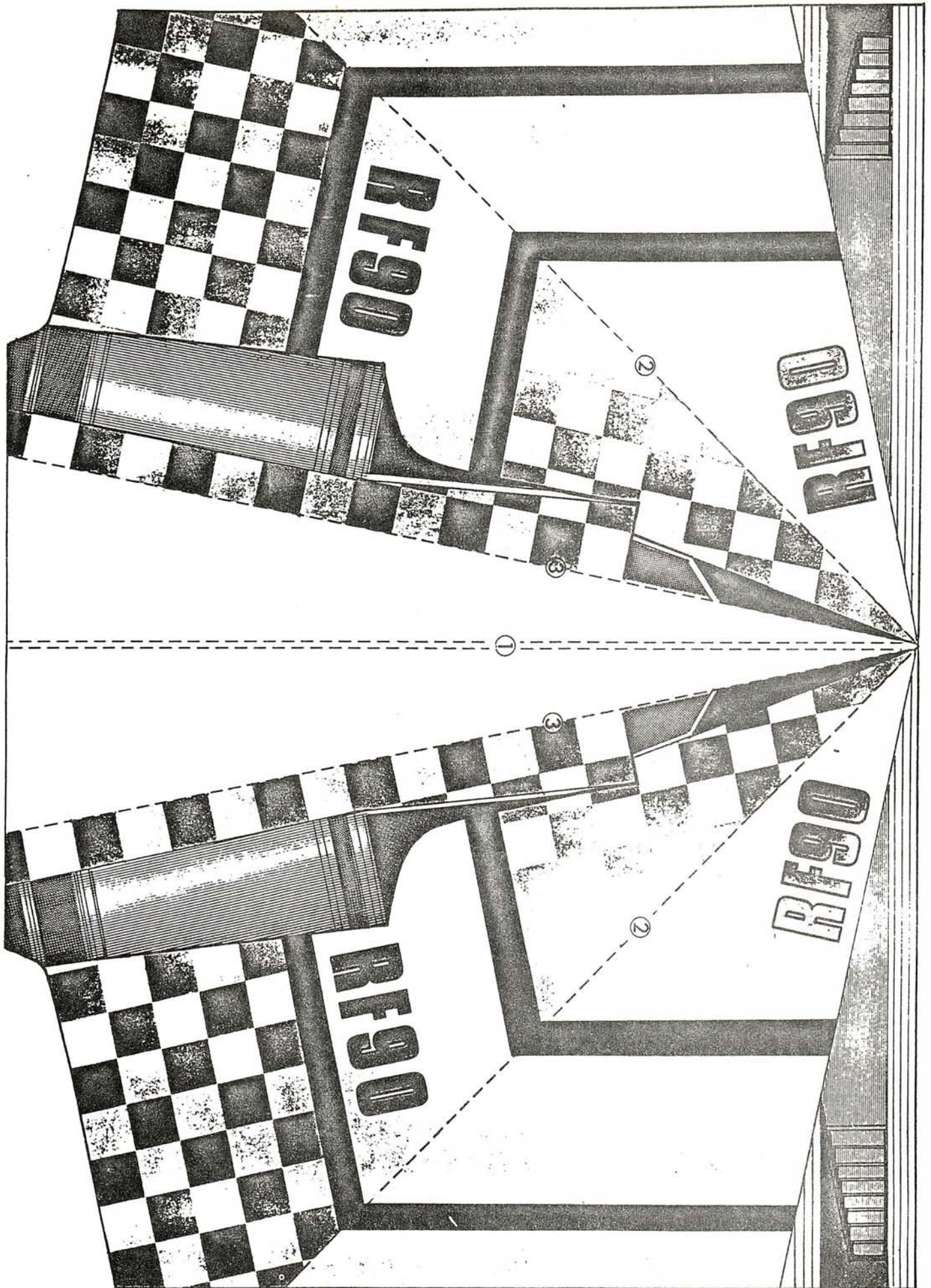

5. ROUTEFINDER

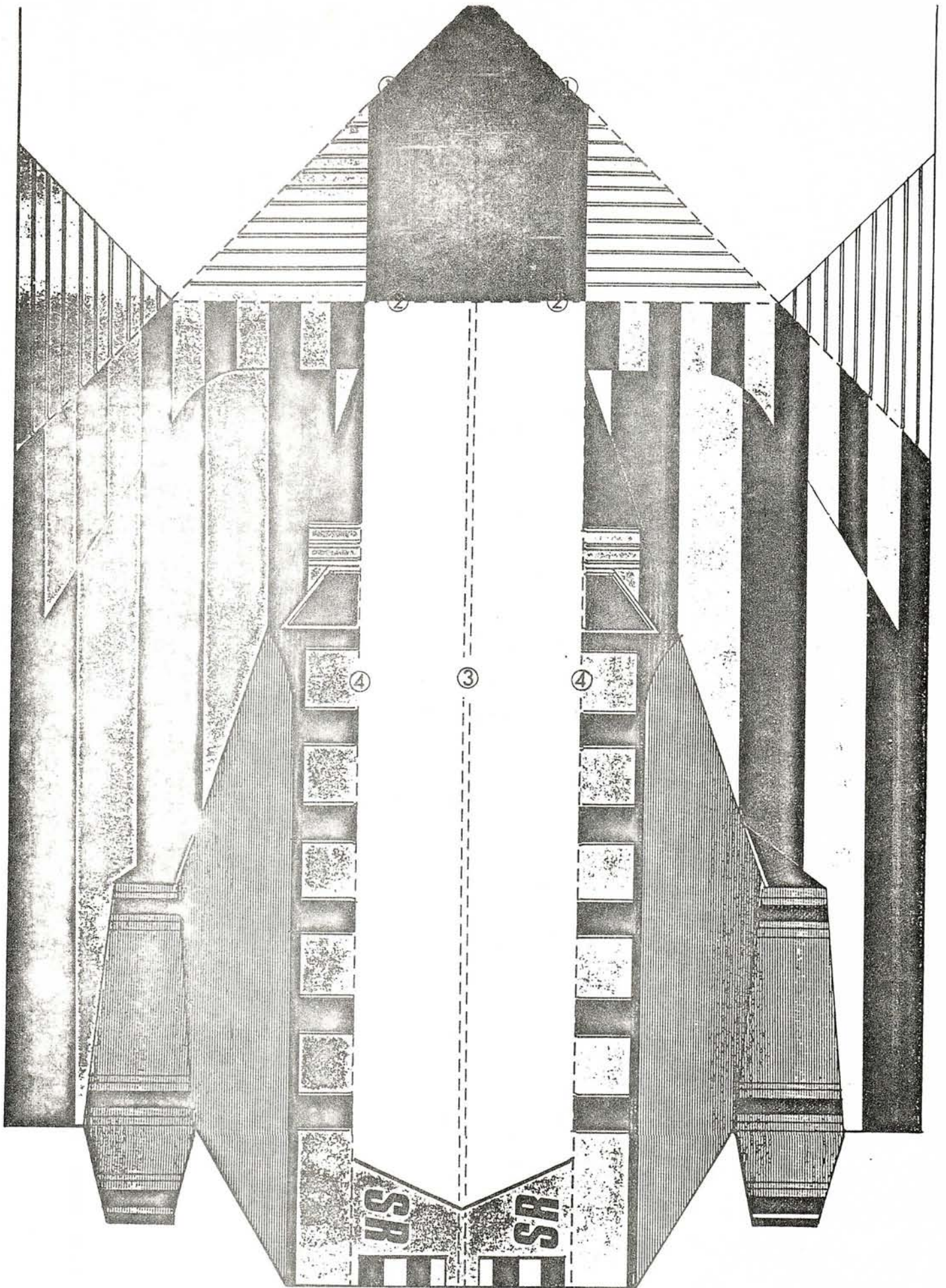

6. SPACE RAM

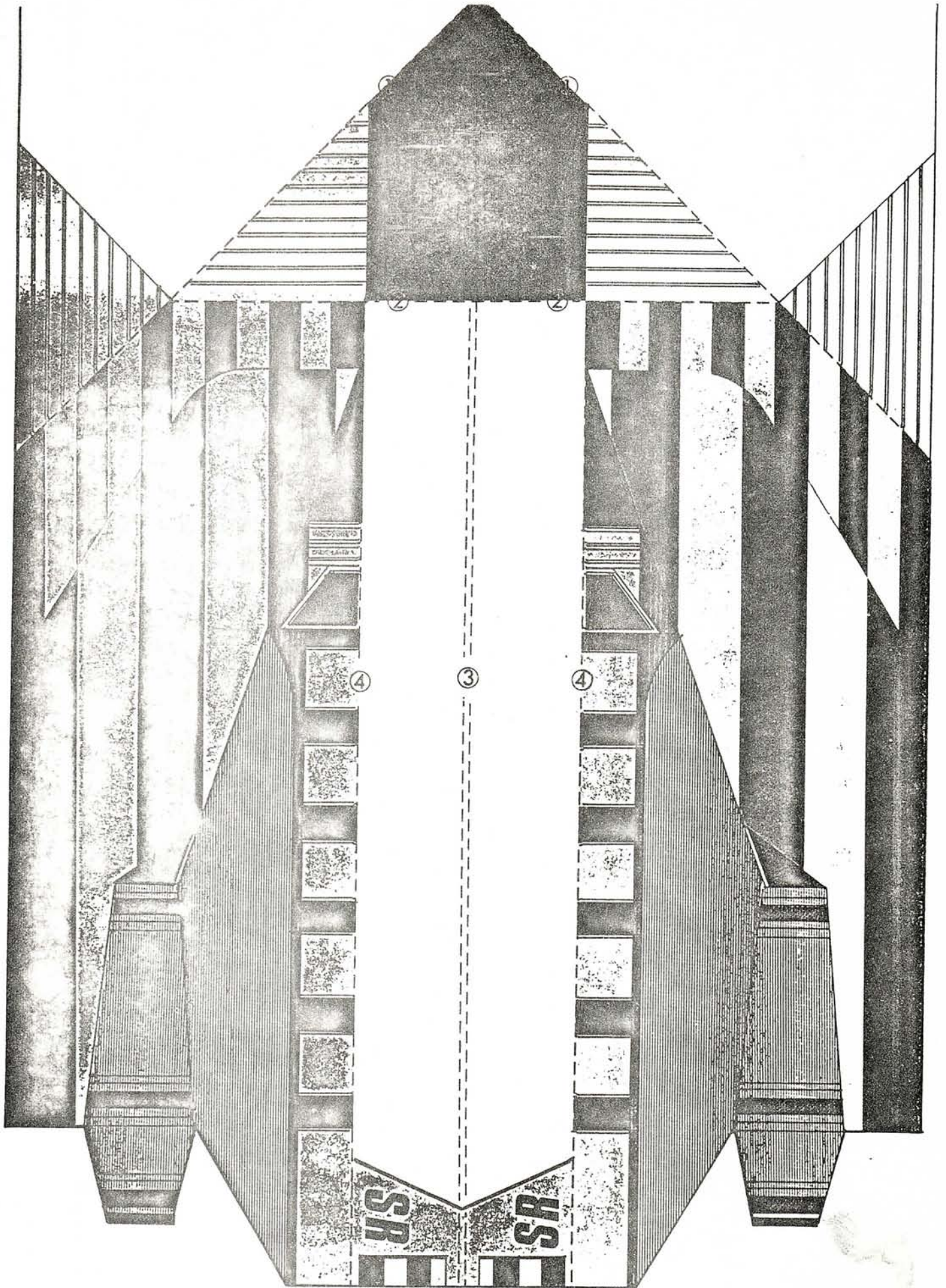

6. SPACE RAM

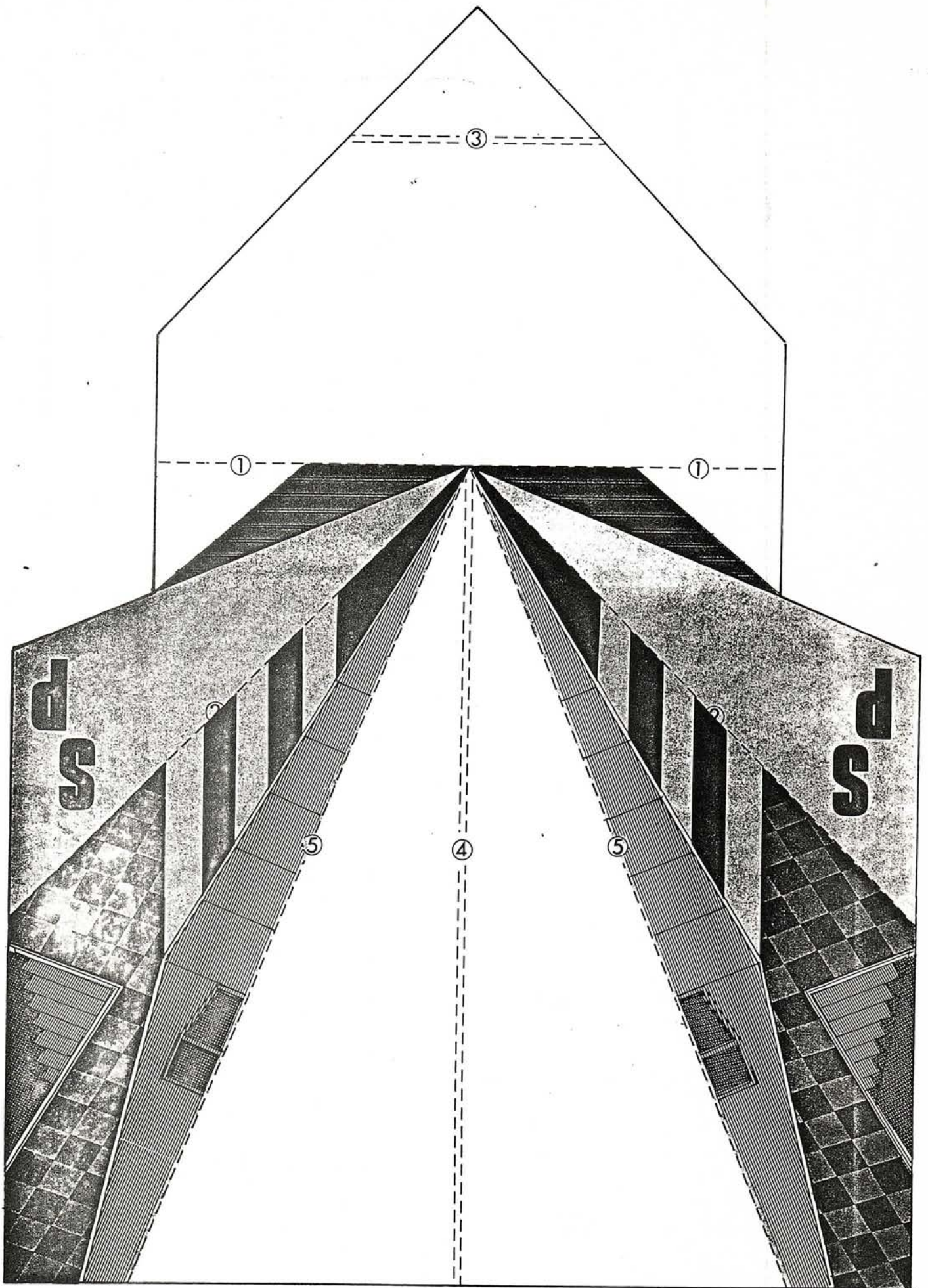

8. STAR PROBE

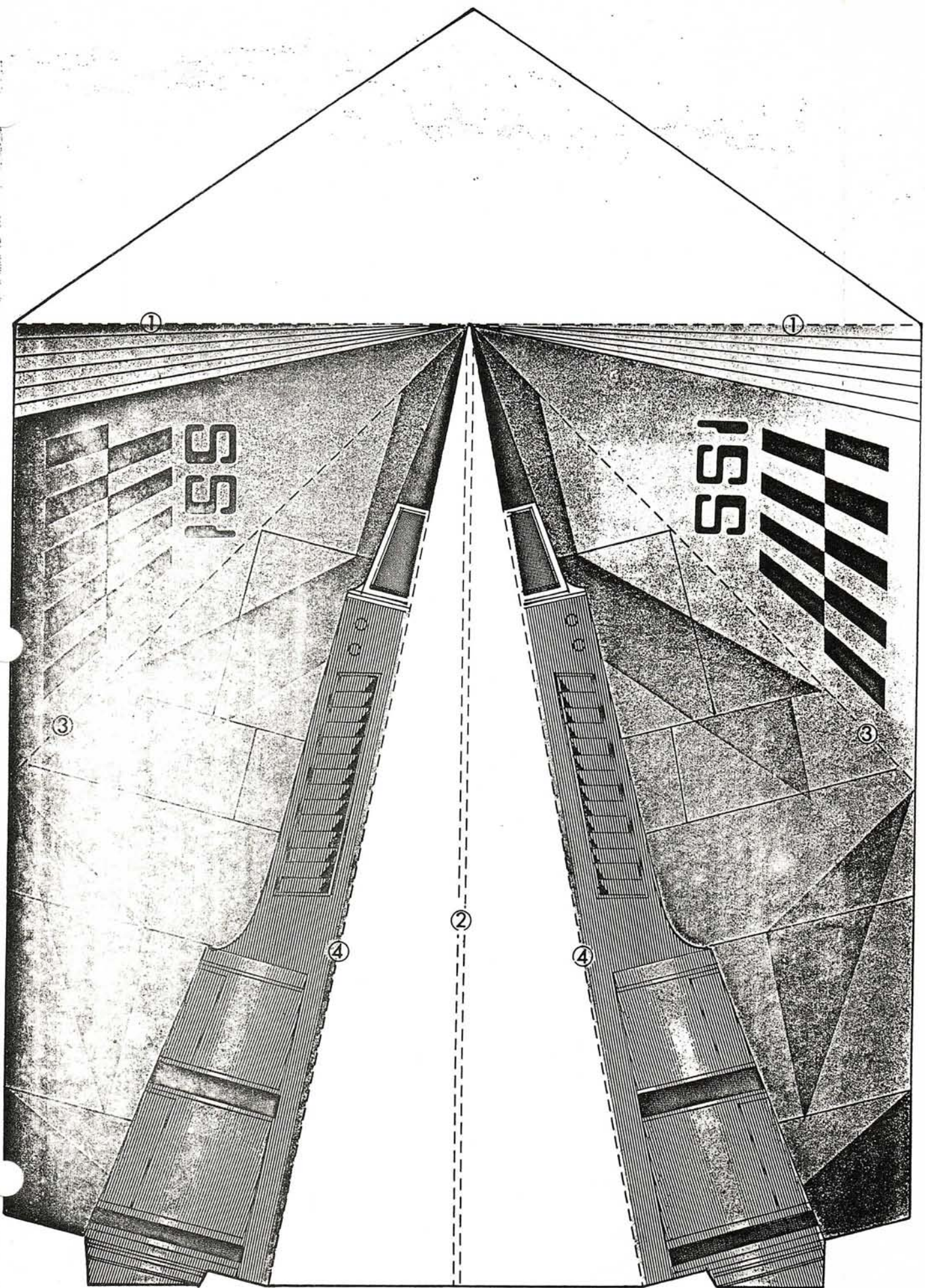

9. SPACE SEARCHER

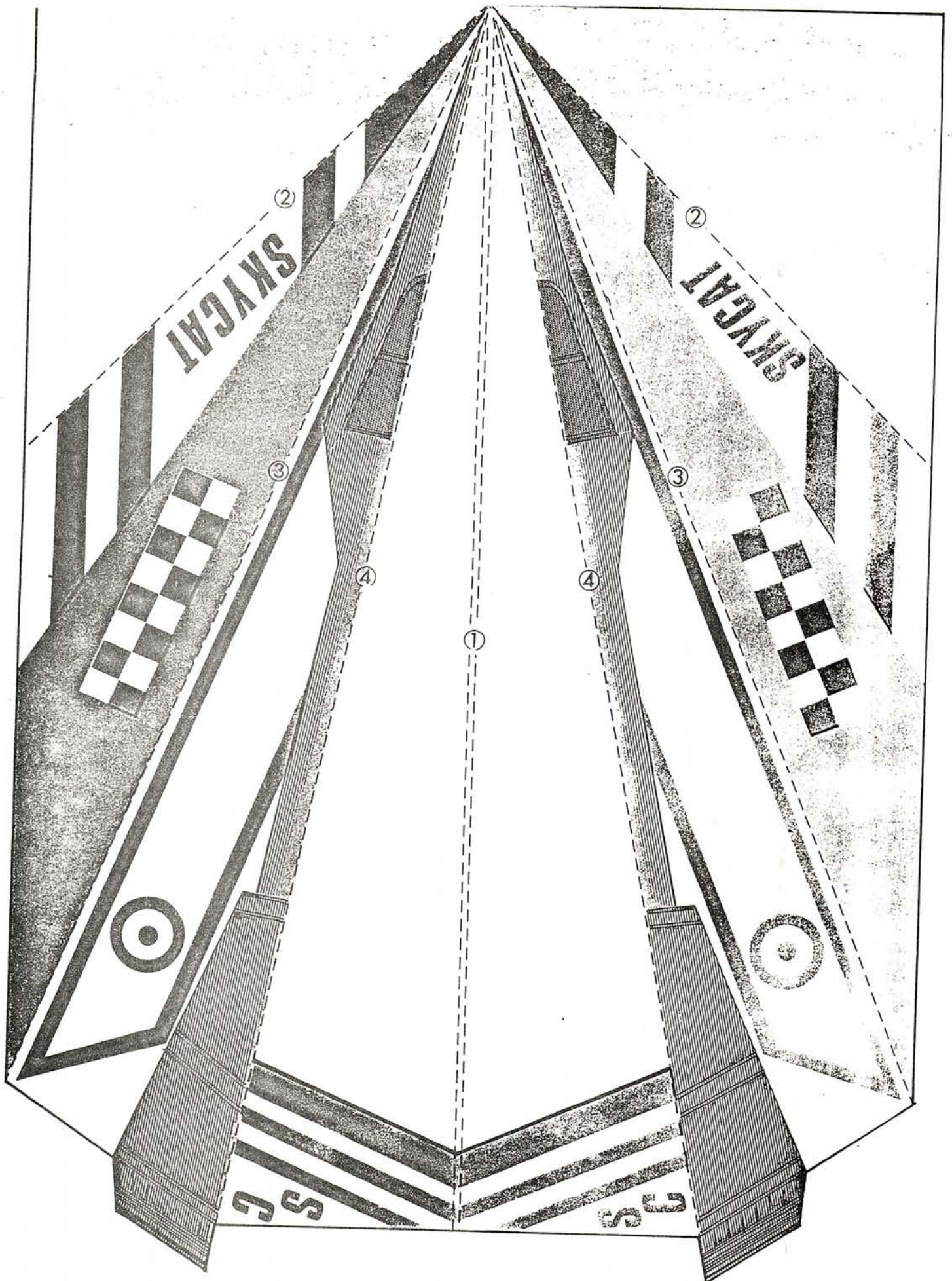

10. SKYCAT

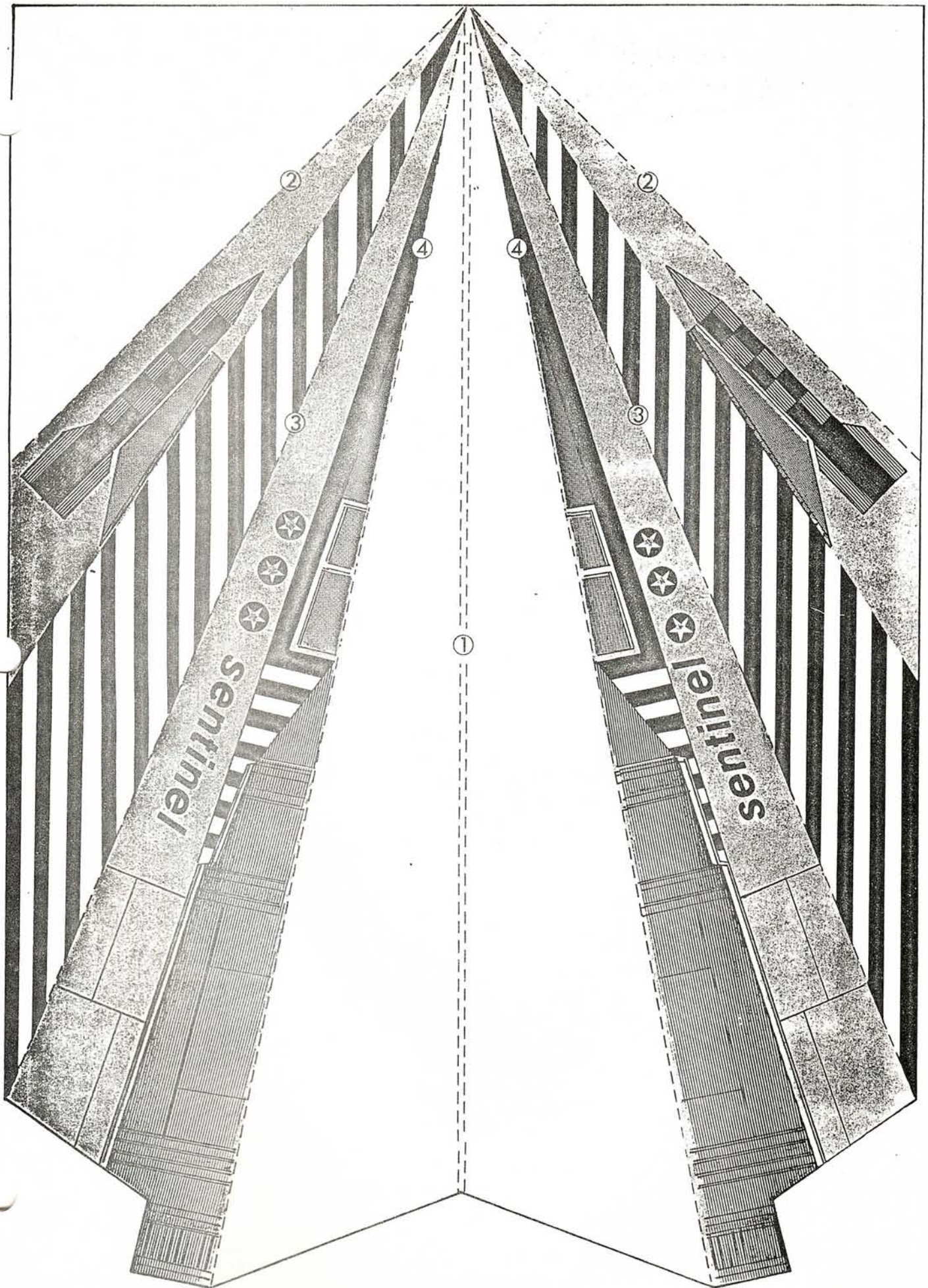

11. SPACE SENTINEL

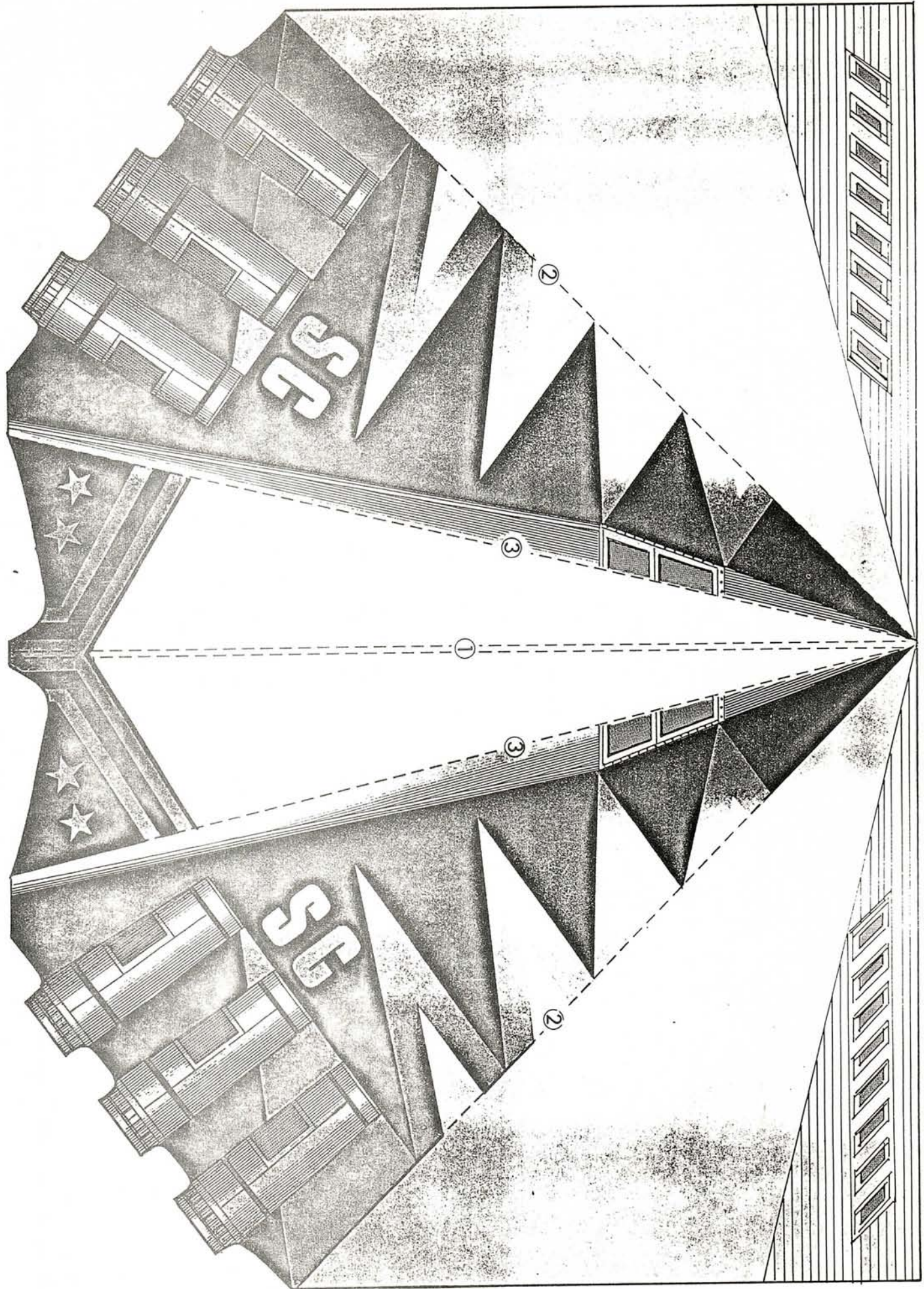

12. STAR CRUISER

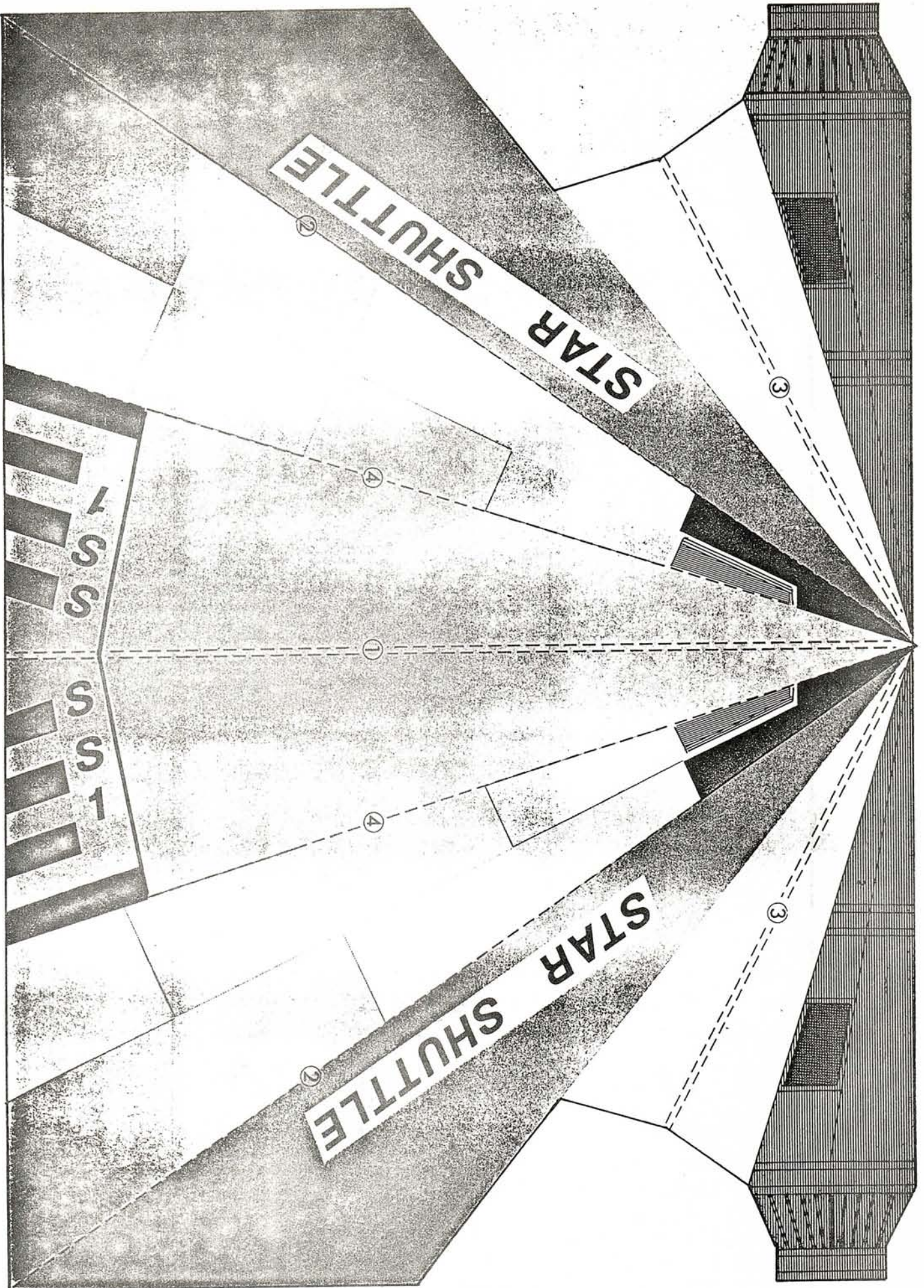

13. STAR SHUTTLE

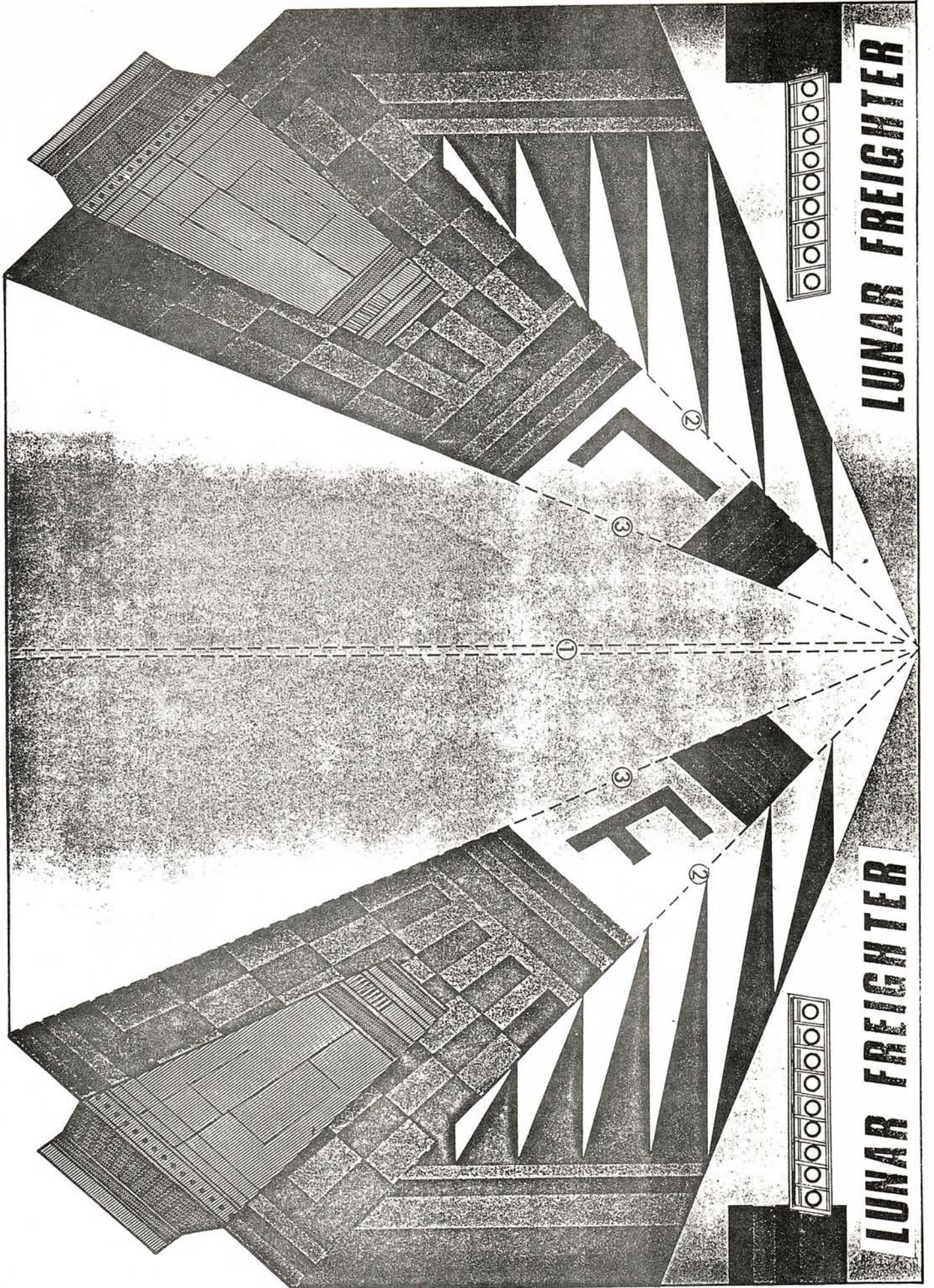

LUNAR FREIGHTER

LUNAR FREIGHTER

14. LUNAR FREIGHTER

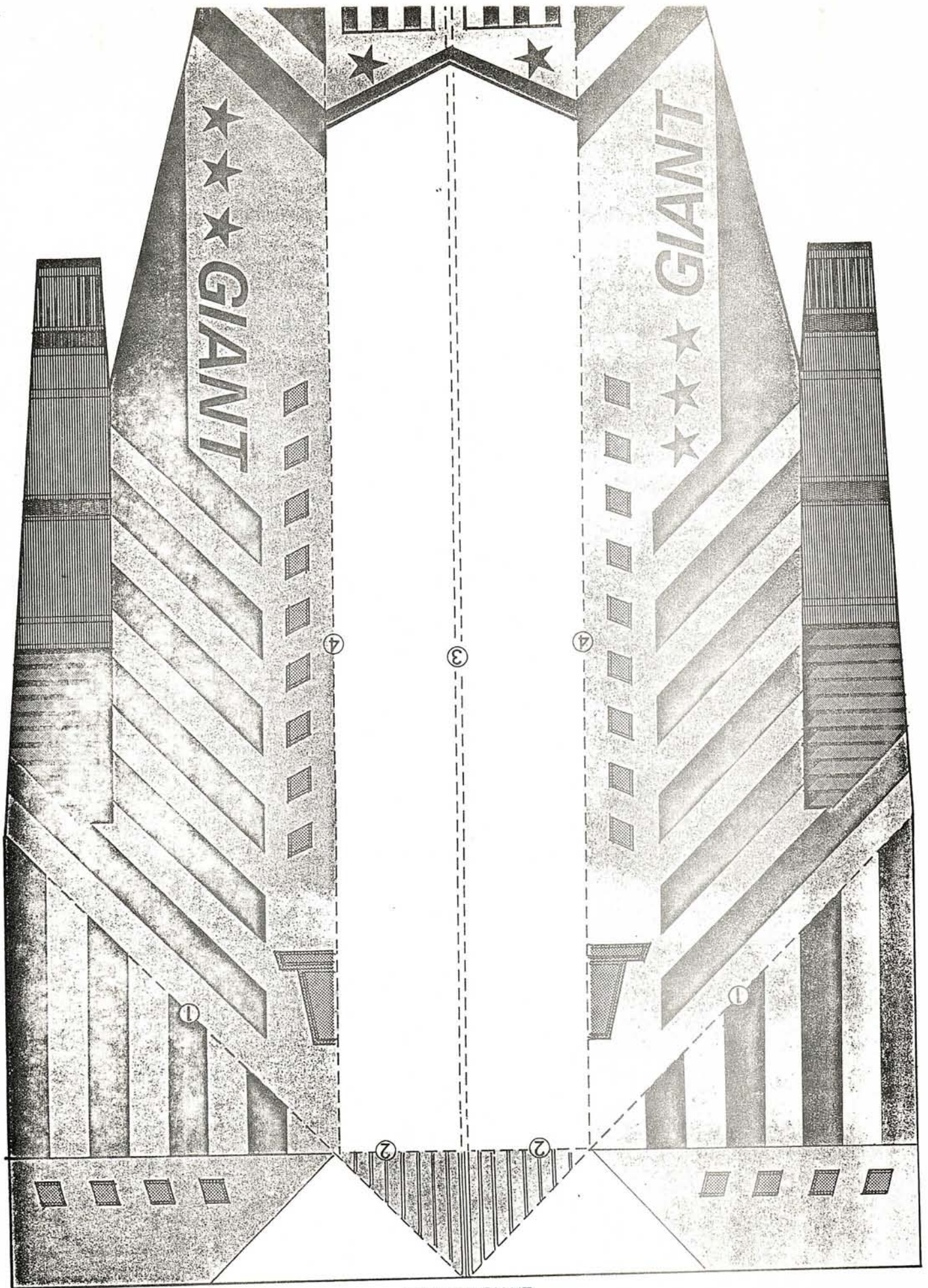

15. STAR GIANT

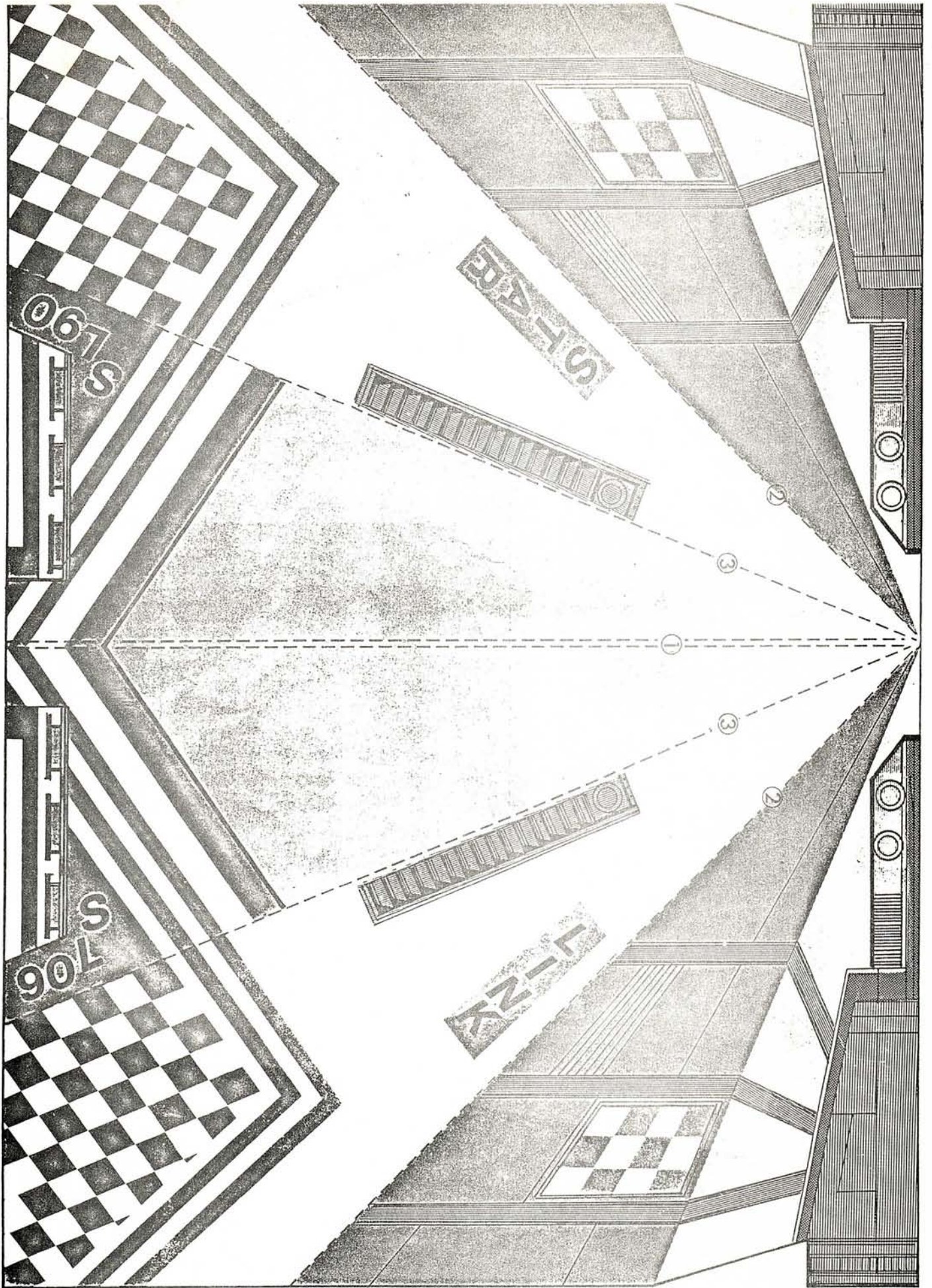

16. STAR LINK

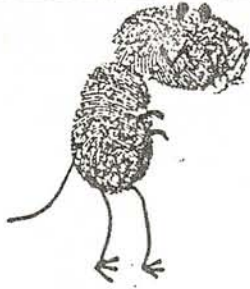

Dinosaur

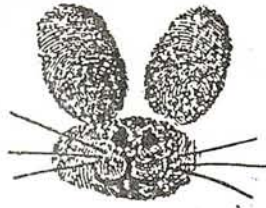

Bunny

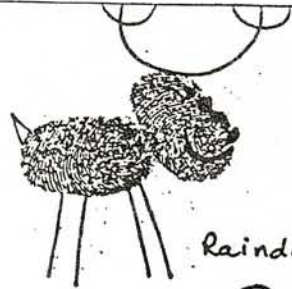

Reindeer

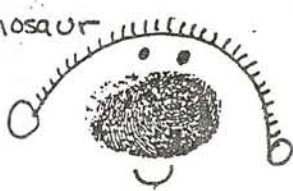

Catpiller

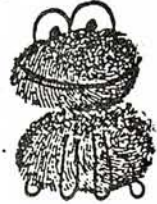

frog

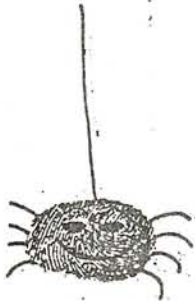

Spider



Beaver

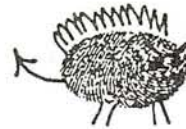

Monster



Birthday
Cate



Owl



Dog

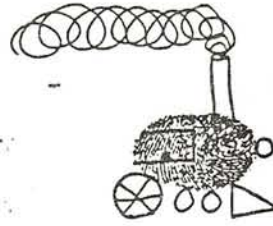

train



Hamster



Bird



Bee



Halloween



Lady
Bug



Dog



elephant



turtle



Bear



Basket Ball Player



Boy Running



Boy Bowling



girl running



Boy Boxing

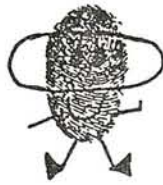

Scuba



Football



girl skiing



tennis



George Washington



Princess



Fireman



chick



Devil



witch



cat

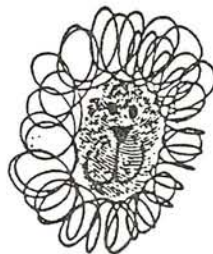

Lion



Pilgrim

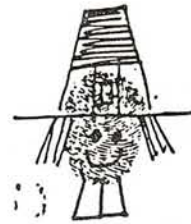

Pilgrim



SANTA

Animal Tracks



front

O'possum



hind



front

Raccoon



front

Gray
Squirrel



hind



hind



front

Beaver



hind



Red Fox
(front)

Muskrat
(hind)



Striped Skunk
(hind)

Use carbon paper to trace tracks on linoleum blocks. Cut out with scissors, and etch lines with x-acto knife or something similar. Glue to wooden blocks. Use with foam ink pad.



Woodchuck
(hind)



Mink
(front)



White-tailed Deer
(front)

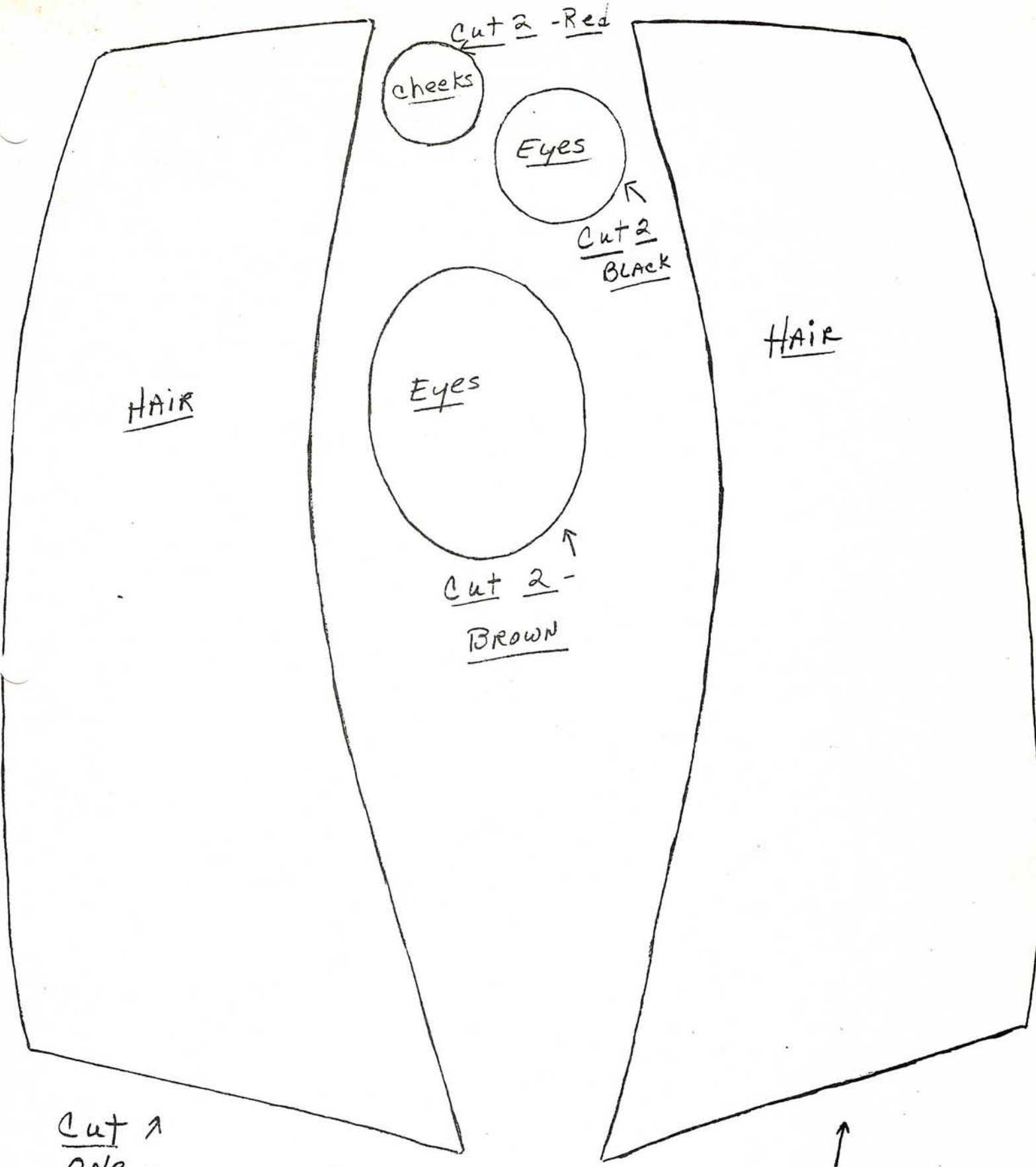

Cut 1
one -
Brown

↑
Cut one - Brown

Use ONE Paper Plate

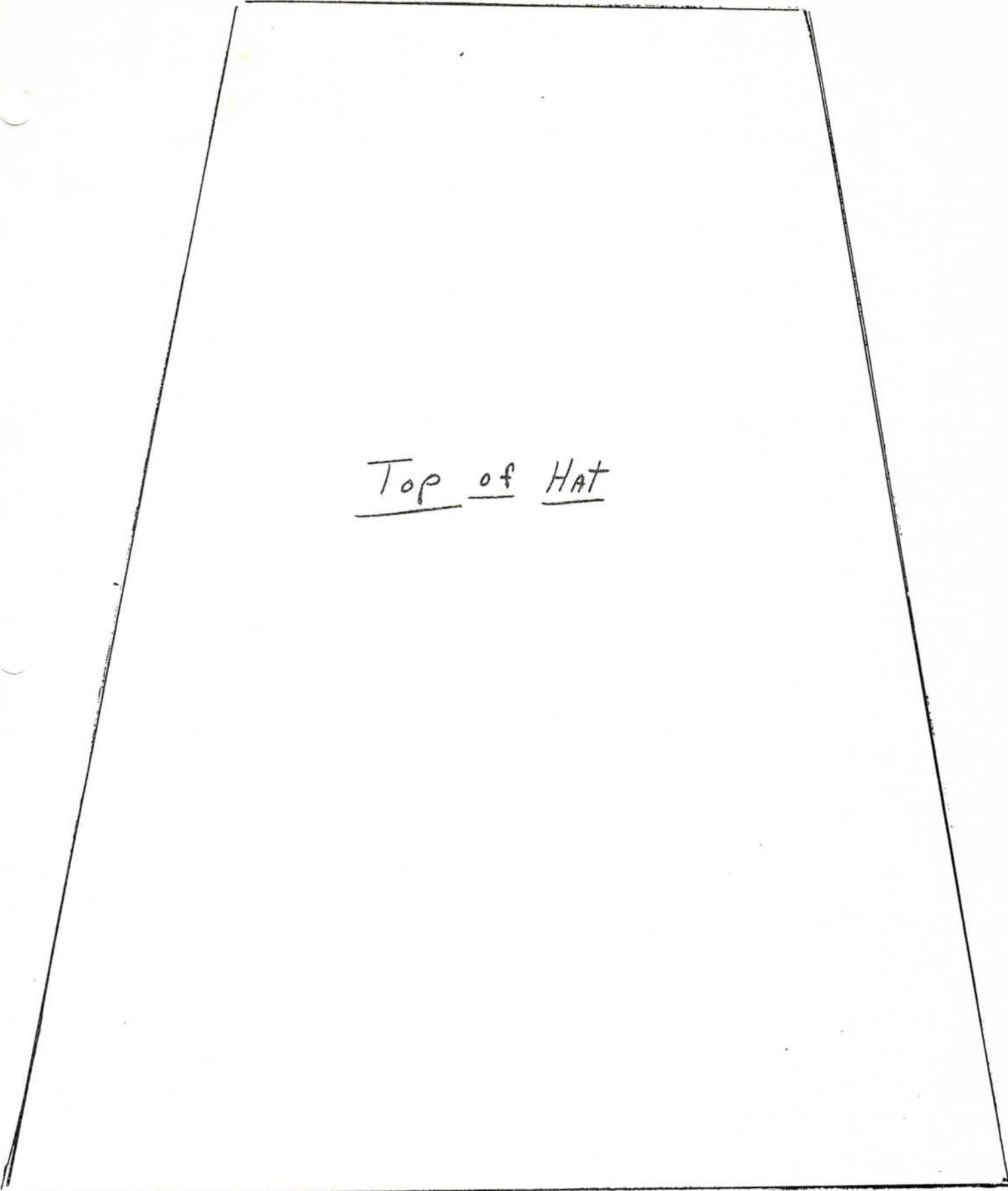

Top of HAT

Cut one - Black

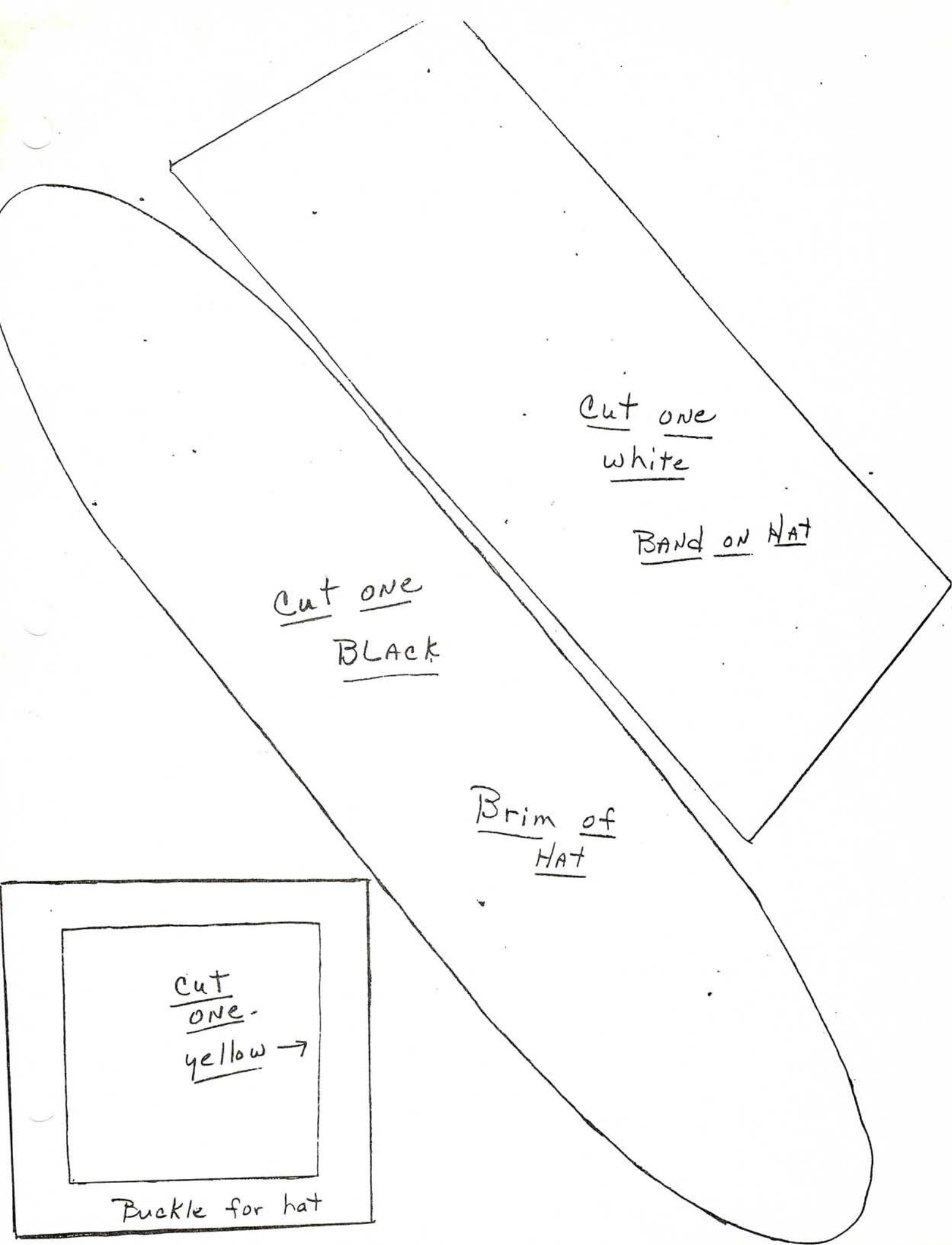

cut one
BLACK

cut one
white

BAND ON HAT

Brim of
HAT

cut one
yellow ->

Buckle for hat

If there is time the guests may tell what was in their loaded ships. The first may say, "I sailed the seven seas, and in my ship I had a chest." The second man repeats what has been said and adds an article. Each in turn repeats all the articles and adds one more. When a person gets one article out of order or forgets one, he withdraws from the game. The person to remember the most articles wins the contest.



SHADOW PIRATES

As the bold men of the seas swaggered about, John asked them to determine to which crew they would belong. He passed around a wooden bowl in which were slips of paper with the names, "Ship of Bones" and "Ship of Skulls," written on them. He explained that pirates just had to have information about each other's crews and that sometimes they had to make their decisions when vision was blurred by distance, fog, or twilight. Guessing shadow pirates, he pointed out, would give them good practice. Hanging a sheet in the center of the room, he asked the members of the crew of the "Ship of Bones" to sit on boxes on one side of it and gave each one a sheet of paper and a pencil. He placed a lamp on the other side of the sheet and requested the crew of the "Ship of Skulls" to gather over there.

"Pirates came from all walks of life, you know," he explained "and often they tried to hide their identity by assuming a hunch back or queer ways of walking." He directed a member of the crew of the "Ship of Skulls" to walk past the sheet casting a good profile shadow. The members of the other crew guessed at the identity and wrote down the real name and the assumed. One by one the pirates paraded until each had a turn. Then the two crews changed places, and the crew of the "Ship of Skulls" endeavored to identify the members of the crew of the "Ship of Bones." John gave three prizes, one to a boy who had the most real names correctly identified with the shadows, one to a girl who paired the most chosen names with the real names correctly, and one to a boy whose shadow only a



BOAT FAVOR: Punch holes in top and bottom of striped paper sail and write name. Insert soda straw mast through holes and set mast into large filled nut cup.

TREASURE HUNT

All Ages

Equipment: The out-of-doors! A list of objects for each team. The list might include such items as different kinds of leaves, rocks, shells.

Method: The group is divided into teams. Each team is given a list of objects. On signal, each team begins to search. The team collecting and identifying the greatest number of specified objects wins the game.

Variation: The boy make up a list of objects such as birds, plants, flowers, or fungi to look for on their hike. If one of the objects of the hike is to study flowers, the game might be scored as follows: trillium, two points; bloodroot, one point; hepatica, one point; anemone, one point; ladyalipper, five points. Flowers should not be picked.

NATIONAL GOOD TURN FOR SCOUTING HUNT

ROBINSON CRUSOE

Equipment: A list of requirements for shipwrecked partners, Robinson Crusoe and his man Friday. This list might include: find something edible; find something to use as tools and utensils; find drinking water; find shelter.

Method: A definite area is decided upon for the game. Each pair is given a list of the requirements. On signal, the search begins. The first pair complete its list wins.

Variation: Shipwrecked crews. Each patrol is given certain articles which have been salvaged from the wreck such as canvas, poles, rope, knife, hatchet, compass. They are required to explore a given area, choose a site, and construct a shelter. Considerations of availability of food and water, shade, prevailing wind, should play a part as well as shurdiness and workmanship. Patrol creating best shelter is saved by next passing ship.

PIRATE PIN: Draw or paint a pirate's face on half a walnut shell. For earrings, loop yarn through a tiny bone ring and glue in place. Stuff shell with cotton. glue on fabric backing and add a safety pin.



USE LARGE CARBOARD APPLIANCE BOX. CUT LARGE SQUARE ON TOP. CUT SMALL HOLE FOR FLAG POLE.



V e s l

CUT, FOLD

PLASTIC GARBAGE BAG

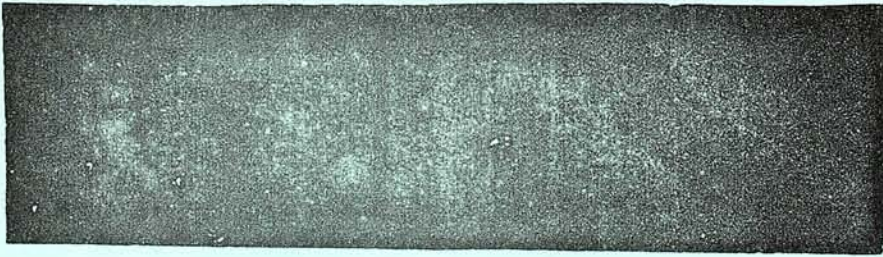

CUT ARM HOLES, ADD FRINGE, AND TAPE AT TOP

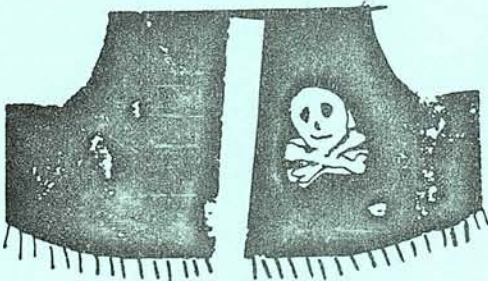

Eye patch

THIS AND THAT:

Try to use your theme all month long in anything you do.

Fix a pirate cake. Dubloon cupcakes. Sea Water kool-aid (Blue).

Play Doubloon tick-tack-toe. Pirate bone shuffleboard.

NALITICAL TERMS:

"Ahoy Mates" a greeting to fellow pirates

"Galley" Kitchen

"Grog" Pirate drink

"Dobloons" Pirate money, gold coins

"Booty" Treasure

"Landlubber" Someone who'd rather stay on land

"Starboard" the right side of a ship

"Port" The left side of a ship

Get funny books from Captian D's.

Make cardboard pirate ship.

Do a pirate skit for Pack Meeting.

Hi!

Making Christmas ornaments is a family tradition in many homes. It's fun to gather the family together and make ornaments for the family tree. These "putter cup" ornaments can be personalized with each family member's name and the date. Through the years they will become treasured keepsakes as each special ornament is taken from the box, unwrapped and hung on the tree.

Here are 10 projects that are easy and inexpensive. You can proudly display them on your mantle or hang them on your tree; yet they are simple enough that your youngsters can make them to give as gifts to their teachers and friends. Look for my other project sheets if you are having birthday parties, weddings or showers, or need simple craft ideas for scouts, classrooms or bazaars. "Putter cups" come in pink, white, brown, red, yellow and our popular crystal.

Happy puttering!

"Mrs. Putter"



GENERAL DIRECTIONS

Glue: Use a thick, tacky glue that dries clear. Attach eyes and noses by applying dots of glue on the pom-poms and attaching the eyes and noses to the glue. Glue must be dry before materials are firmly attached to the cups. Let dry before handling.

Bows: Follow the figures for making a bow. Pinch the ribbon tightly together in the center. Wrap with fine spool wire. The tighter you pinch, the puffier the bow.

Writing on Cups: Be sure the pen you pick will write on smooth plastic. A Sharpie® works very well. The colors are bright, adhere well, and are water-resistant.

Holes: Have a lighted candle on your work table. Heat a corsage pin or stem wire. Insert one time for a small hole. Re-heat and re-insert with a circular motion for a larger hole.

Ribbon: If the width of ribbon that is called for in a project is not available, cut a lengthwise piece the proper width from a wider piece of ribbon.

Substitutions: These projects should spark your imagination! If you can't find the exact same miniatures or the exact same colors, don't be afraid to substitute what is available to you.

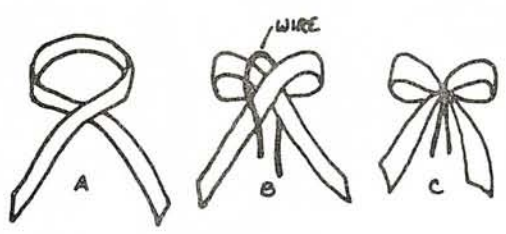

SINGLE LOOP BOW

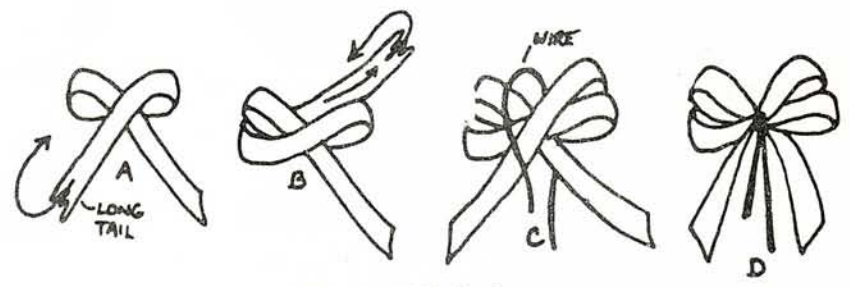

DOUBLE LOOP BOW

DEER SCENE

Any small miniature will go in these cups. A dozen of these would make such a nice Christmas gift. Great for table trees!

Materials: 1 crystal "putter cup," 2 miniature deer, 5" of #9 red velvete ribbon, 8" piece of thin gold cord, 3" x 3" green felt, 1 - 8 mm green faceted bead, white glitter, cardboard.

1. Use the cup rim as a pattern. Cut out a cardboard circle. Cover both sides with green felt.
2. Apply glue to the center surface of the circle. Press glitter onto the glue. Cut the legs from one deer. Apply a drop of glue to the feet and bottom of the deer. Glue onto the glittered surface. Let dry.

Refer to Step 2 in the "Angel Scene" for the hanger. Cut four lengthwise strips of ribbon 3/16" wide.

Draw lines on back of ribbon. Cut two strips 4" long. Make two Figure-8 bows (Figure 1). Glue the bows one on top of the other (Figure 2).

5. Glue the cup over the scene. Glue a strip of ribbon around the top. Glue a strip of ribbon around the bottom. Glue the bows to the bottom of the cup.

6. Slip the bead onto the hanging loop. Glue it to the top of the ornament.

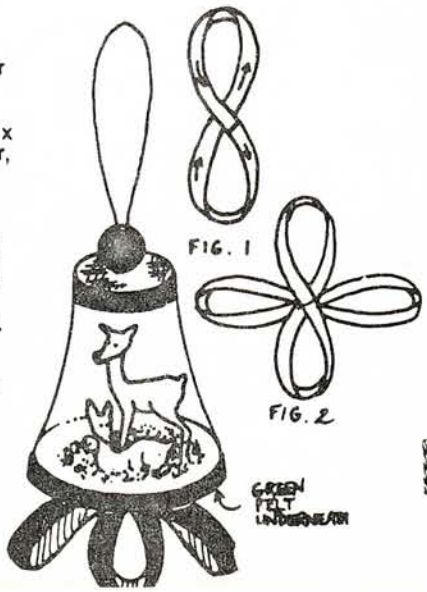

NEW YEAR'S HOURGLASS

Materials: 2 crystal "putter cups," yellow tagboard, 8" red grosgrain gift wrap ribbon, gold glitter, red pen, salt

1. Melt a 1/8" hole in the center bottom of each cup. Glue the two cups bottom to bottom.

2. Using the cup rim as a pattern, cut two yellow tagboard circles. Write "Happy New Year" on one side of each circle. Glue one circle to the bottom cup rim. Set aside.

3. Peel 3" at each end of the ribbon into four narrow strips. Leave the center 2" unpeeled (Figure 1). Run the ribbon strips between your thumb and scissors blade to curl them. Glue the middle 2" around the center of the hourglass, leaving the curls free to intermingle in front.

4. Pour about a half a "putter cup" of salt into the hourglass. Glue the other circle on top.

5. Apply glue around the top and bottom edges. Sprinkle with gold glitter. Let dry.

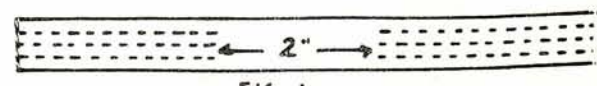
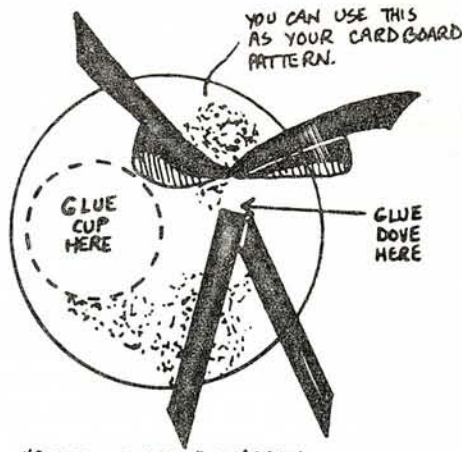

FIG. 1

PEACE ON EARTH CANDY CUP

Materials: 1 white "putter cup," 9" narrow dark blue ribbon, 2" x 2" light blue felt, 1 dove miniature, 1 tiny star sequin, white glitter, 3" fine spool wire, blue pen, light cardboard.

1. Cut a 1 1/4" cardboard circle. (See diagram.) Cover with blue felt leaving felt extending slightly over the edge.
2. Write "Peace on Earth" on the cup. Glue on the star sequin as in the photo. Glue the cup to the spot indicated in the main diagram. Brush a small area of felt with glue. Sprinkle with white glitter to simulate snow.
3. Cut two 1 1/2" ribbon tails. Make a single loop bow with the remaining ribbon. Glue the tails and the bow as in the main diagram. Glue the dove to the spot indicated, over the ribbon tails.



"PEACE ON EARTH" DIAGRAM

CHOIR BOY

Materials: 1 red and 1 white "putter cup," 1 each black, white and pink 1" pom-pom, small pieces of white, black, red, and pink felt, and green construction paper.

1. Cut out felt pieces. Cut a 1" x 1 1/2" piece of construction paper for his book. Crease book in half.
2. Glue the hands to the sleeve ends. Glue the book to the hands (Figure 1). Glue to either side of the white cup.
3. Glue the white pom-pom into the white cup. Turn red cup upside down and glue the white cup on top.
4. Cut the string that holds the black pom-pom together. Apply glue to the top of the pink pom-pom. Glue strands of black for hair. Glue the head to the top of the white cup.
5. Glue on eyes and nose. Cut two narrow 3/4" pieces of felt. Glue under his chin for a tie.

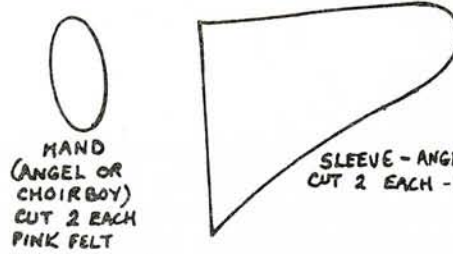

CHOIRBOY DIAGRAM (SIDE VIEW)

ANGEL

Materials: 3 white "putter cups, one 1/2" white pom-pom, one 1" pink pom-pom, one 2" gold pom-pom, pieces of white, pink, red and green felt, and one gold glitter stem.

1. Melt four holes 1/4" apart into one cup for the wings (Figure 1). Set aside.
2. Cup two 4 1/4" pieces of glitter stems. Bend each into a wing shape (Figure 2). Apply glue to the ends of the wings. Insert into the holes.
3. Glue two cups together, one inside the other. Glue the 1/2" white pom-pom into the cup with the wings. Apply glue inside the cup beneath the wings. Glue this cup over the other two, allowing the front of the cup to extend forward. (See diagram.) Let dry.
4. Cut out all felt pieces following patterns. Glue the hands to the sleeves. Glue the hands plus 1/4" of the sleeve together as if praying. Glue the shoulders to the sides of the cup. Bring the sleeves in and glue to the center front forming two loops for the elbows. (See diagram.)
5. Cut the string that holds the 2" gold pom-pom together in the center. Apply glue to the top, back and sides of the 1" pink pom-pom. Lay small pieces of the pom-pom fibers onto the glue for hair. Trim as necessary.
6. Glue on eyes and mouth. Glue head to top of cups. Curve the remaining piece of glitter stem into a circle for the halo. Glue the halo to the head.



ANGEL DIAGRAM

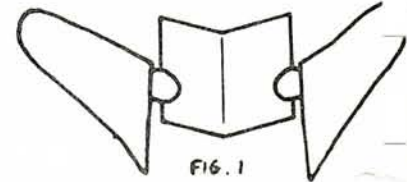

FIG. 1



FIG. 2

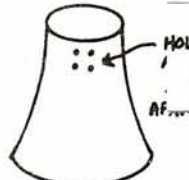
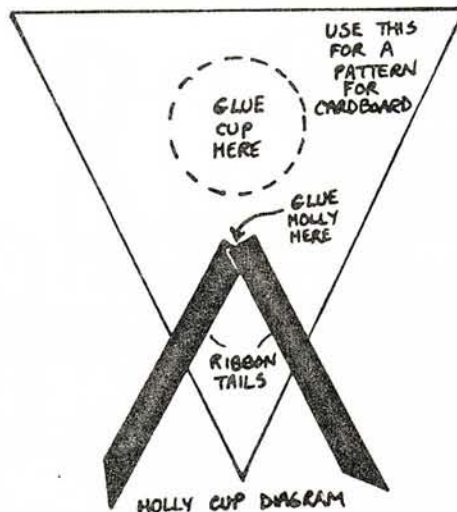

FIG. 1

CHRISTMAS HOLLY CUP

Materials: 1 red "putter cup," 3" piece of #40 red gingham ribbon, 2" piece of #2 white ribbon, mini holly pick, light cardboard.

1. Cut out a cardboard triangle. (See diagram.) Cover with ribbon leaving ribbon extending slightly over the edge.
2. Cut the white ribbon in half lengthwise. (See diagram.) Glue ribbon and cup to the cardboard.
3. Cut the stem from the holly leaf. Glue the holly over the ribbon tails. (See diagram.)



HOLLY CUP DIAGRAM

BELL OF BEADS

Materials: 1 crystal "putter cup," red felt, 7" gold soutache braid, 6" thin gold cord, 8mm faceted beads in red and green, two 10 mm gold beads, cardboard.

1. Fill the cup with red and green beads mixing the colors. Set aside.
2. Use the rim of the cup as a pattern and cut a cardboard circle. Cover both sides with felt. Glue to the top of the cup. Turn cup over.
3. Use the narrow end of the cup as a pattern and cut a red felt circle. Snip a tiny hole in the center. Knot the ends of the gold cord to make a loop. Slip the loop up through the hole. Apply glue to the knot and the felt circle. Glue to the top of the cup.
4. Glue gold soutache braid around the top and bottom edges of the cup.
5. Slip the hanging loop through one gold bead. Glue the bead to the top of the ornament. Glue the other gold bead to the center bottom.

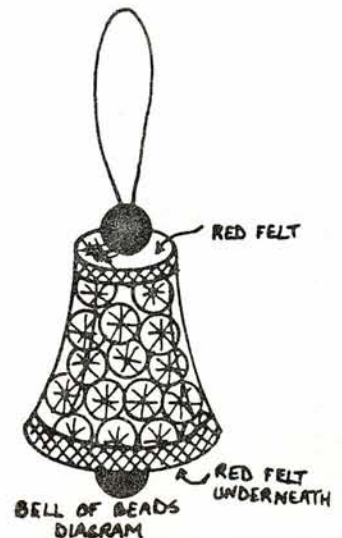

BELL OF BEADS DIAGRAM